



Sistema MINIPOL

ARMARIOS MONOBLOC

Dos tipos de puerta

- **Opaca:** permite la instalación de aparamenta en su interior.
- **Transparente:** combinada con placa de montaje, chasis y/o puerta interior permite ver el estado de la aparamenta, manteniendo el grado IP.

Color gris RAL 7035

También disponible en beige, gris oscuro o verde. Opcionalmente, posibilidad de otros colores.

Fácil mecanización

Plantillas verticales en el interior de las puertas para la correcta colocación de la aparamenta.

Facilidad de montaje

Cremallera de fijación rápida para tornillería M6. Permite el montaje sin taladrar.

Personalización

Servicio de premechanizado para cubrir las necesidades de cada cliente.

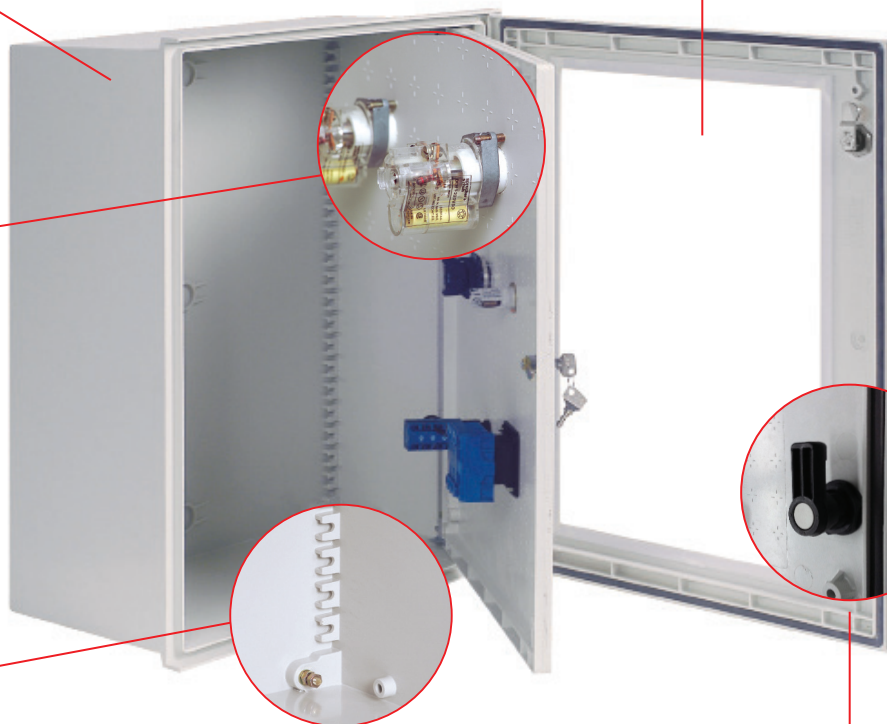

Sistemas de cierre

Distintos sistemas de cierre y enclavamiento. Posibilidad de personalización bajo demanda. **Ver p16**

Doble barra



Cierre de 3 puntos





Monobloc : compacto

Producto moldeado en un solo bloque



Autoextinguible

a 960° C



Grados de protección

Resistente a la corrosión y los agentes climáticos

- **IP66** según IEC 60529
- **IK10** según IEC 62262 (estándar)
- **IK08** según IEC 62262 (con ventana)



Certificación UL

Gama aprobada por UL. Si precisa esta certificación, rogamos contacte con nosotros.

Seguridad

La puerta interior y el chasis mantienen el **IP20** cuando la puerta exterior está abierta.



Fijación

Montaje en poste



Montaje mural

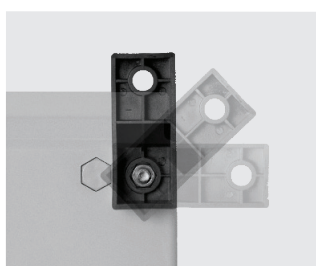

Bisagras interiores en ZAMAK

Solidarias a la puerta, permiten una apertura de 180°
Opción INOX AISI 316, bajo demanda.



Datos técnicos

Material: Poliéster reforzado con fibra de vidrio (GRP)	color RAL7035	IEC 62208
Resistencia mecánica (impactos)	IK10	IEC-62262
Protección contra polvo-agua	IP-66	IEC-60529
Doble aislamiento	Clase II	EN 60439-1
Resistencia a la corrosión	Sí	IEC 60068-2-30
Clase Térmica	A	UNE-21305
Material autoextinguible	960°	IEC 60695-2
Rango de temperatura	-30° +105°	IEC 60670
Voltaje Nominal	1.000 V	IEC 60439-5



Gama de productos

ARMARIOS

ACCESORIOS

		Diimensiones (mm) Alto x Ancho x Profundidad					
		300x250x140	400x300x200	400x400x200	500x400x200	600x400x200	
	Puerta lisa 2 cierres doble barra DIN 3.0 mm (estándar) IP66	MN 321 0470071 (1 cierre doble barra)	MN 432 0470072	MN 442 0470024	MN 542 0470073	MN 642 0470095	
	Puerta lisa Cierre de tres puntos, con maneta escamoteable Cierre doble barra DIN 3.0 mm IP66	-	MN 432/3P 0472171	MN 442/3P 0472172	MN 542/3P 0472173	MN 642/3P 0472174	
	Puerta transparente 2 cierres doble barra DIN 3.0 mm (estándar) IP66	MN 321-V 0470071-V	MN 432-V 0470072-V	MN 442-V 0470024-V	MN 542-V 0470073-V	MN 642-V 0470095-V	
	Puerta transparente Cierre de tres puntos, con maneta escamoteable Cierre doble barra DIN 3.0 mm IP66	-	MN 432/3P-V 0472171-V	MN 442/3P-V 0472172-V	MN 542/3P-V 0472173-V	MN 642/3P-V 0472174-V	
	Placa base de poliéster Espesor 4 mm	MN P32 0976771	MN P43 0976772	MN P44 0976779	MN P54 0976773	MN P64 0976795	
	Placa base metálica Chapa de acero galvanizado Espesor 2 mm	MN PM32 0976771-M	MN PM43 0976772-M	MN PM44 0976779-M	MN PM54 0976773-M	MN PM64 0976795-M	
	Placa base perforada (TELEQUICK) Chapa de acero zincado Permite fijación rápida de aparellaje mediante Clip-tuerca de M4, M5 y M6	MN PBR32 0976771-MP	MN PBR43 0976772-MP	MN PBR44 0976779-MP	MN PBR54 0976773-MP	MN PBR64 0976795-MP	
	Puerta interior Fabricada en poliéster Incluye kit completo para montaje en armario	-	MN PI43 0926672	MN PI44 0926679	MN PI54 0926673	MN PI64 0926695	
	Chasis de montaje de aparamenta modular. Compuesto por chasis, carátulas ciegas y perfiles DIN para fijación de la aparamenta	Nº de módulos Nº de filas	-	MN CH43-P3 0926840 24 2x12	MN CH44-P3 0926841 36 2x18	MN CH54-P3 0926842 54 3x18	MN CH64-P3 0926843 54 3x18
	Carátulas ciegas para chasis modular Pretroqueladas para aparellaje DIN Material aislante y autoextinguible	Altura 152 mm Altura 178 mm Altura 202 mm	- - -	- MN CC-300/178 0926743 -	MN CC-400/152 0926740 MN CC-400/178 0926744 MN CC-400/202 0926746	MN CC-400/152 0926740 MN CC-400/178 0926744 MN CC-400/202 0926746	MN CC-400/152 0926740 MN CC-400/178 0926744 MN CC-400/202 0926746
	Fijación a poste para instalaciones exteriores, provisionales de obra, cuadros de alumbrado público, etc. Conjunto de pletinas y bridas ajustables Abrazaderas y perfiles de acero galvanizado	MN FP-250 0947240	MN FP-300 0947241	MN FP-400 0947242	MN FP-400 00947242	MN FP-400 0947242	
	Fijación a poste para instalaciones exteriores, provisionales de obra, cuadros de alumbrado público, etc. (Fleje y hebillas no incluidos)	MN FP-250 0947240-U	MN FP-300 0947241-U	MN FP-400 0947242-U	MN FP-400 0947242-U	MN FP-400 0947242-U	

PLACAS DE MONTAJE (mm)

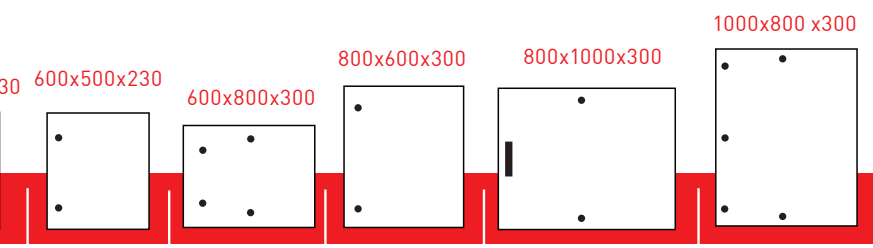

MN 652 0470074	MN 683 0470098	MN 863 0470076	MN 8103 0470841	MN 1083 0470840
--------------------------	--------------------------	--------------------------	---------------------------	---------------------------

MN 652/3P 0472175	MN 683/3P 0472198	MN 863/3P 0472176	MN 8103/3P 04721841	MN 1083/3P 0472840
-----------------------------	-----------------------------	-----------------------------	-------------------------------	------------------------------

MN 652-V 0470074-V	MN 683-V 0470098-V	MN 863-V 0470076-V	MN 8103-V 0470841-V	MN 1083-V 0470840-V
------------------------------	------------------------------	------------------------------	-------------------------------	-------------------------------

MN 652/3P-V 0472175-V	MN 683/3P-V 0472176-V	MN 863/3P-V 0472198-V	MN 8103/3P-V 04721841-V	MN 1083/3P-V 0472840-V
---------------------------------	---------------------------------	---------------------------------	-----------------------------------	----------------------------------

MN P65 0976774	MN P86-68 0976776	MN P86-68 0976776	MN P81-108 0976777	MN P81-108 0976777
--------------------------	-----------------------------	-----------------------------	------------------------------	------------------------------

MN PM65 0976774-M	MN PM86-68 0976776-M	MN PM86-68 0976776-M	MN PM81-108 0976777-M	MN PM81-108 0976777-M
-----------------------------	--------------------------------	--------------------------------	---------------------------------	---------------------------------

MN PBR65 0976774-MP	MN PBR86 0976776-MP	MN PBR86 0976776-MP	MN PBR81-108 0976777-MP	MN PBR81-108 0976776MP
-------------------------------	-------------------------------	-------------------------------	-----------------------------------	----------------------------------

MN PI65 0926674	-	MN PI86 0926676	-	-
---------------------------	---	---------------------------	---	---

MN CH65-P3 0926844 69 3x23	-	MN CH86-4 P3 0926845/ 116 4x29	MN CH86-5 P3 0926845-5 130 5x26	-	-
--	---	--	---	---	---

MN CC-500/152 0926741	-	MN CC-600/152 0926742	-	-
-	-	MN CC-600/178 0926745	-	-
MN CC-500/202 0926747	-	MN CC-600/202 0926748	-	-

MN FP-500 0947244	MN FP-800 Consultar	MN FP-600 0947245	MN FP-1000 Consultar	MN FP-800 Consultar
-----------------------------	-------------------------------	-----------------------------	--------------------------------	-------------------------------

MN FP-500 0947244-U	MN FP-800 0947450-U	MN FP-600 0947245-U	MN FP-1000 Consultar	MN FP-800 0947450-U
-------------------------------	-------------------------------	-------------------------------	--------------------------------	-------------------------------

POLIÉSTER

Ref.	Armario	A	B	C	D
0976771	MN 32	213	268	248	175
0976772	MN 43	260	358	338	222
0976779	MN 44	360	358	338	322
0976773	MN 54	360	458	360	322
0976795	MN 64	360	558	538	322
0976774	MN 65	460	558	538	422
0976776	MN 68/86	556	754	734	518
0976777	MN 108/810	729	956	918	709

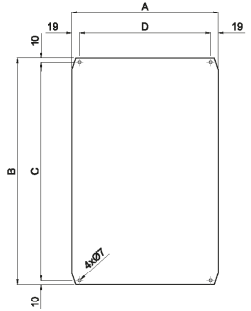

METÁLICA LISA

Ref.	Armario	A	B	C	D	E	F
0976771-M	MN 32	213	268	248	175	148	193
0976772-M	MN 43	254	358	338	222	238	234
0976779-M	MN 44	354	358	338	322	238	334
0976773-M	MN 54	354	458	438	322	338	334
0976795-M	MN 64	354	558	538	322	438	334
0976774-M	MN 65	454	558	538	422	438	434
0976776-M	MN 68 MN 86	550	754	734	518	634	530
0976777-M	MN 810 MN 108	956	729	709	918	609	936

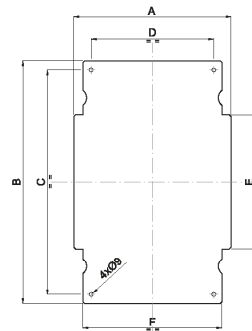

METÁLICA PERFORADA

Ref.	Armario	A	B	C	D	E	F	G	H
0976771-MP	MN 32	202	268	248	175	-	195	200	-
0976772-MP	MN 43	250	358	338	222	354	243	240	160
0976779-MP	MN 44	350	358	338	322	354	343	240	260
0976773-MP	MN 54	350	458	438	322	454	343	340	260
0976795-MP	MN 64	350	558	538	322	554	343	440	260
0976774-MP	MN 65	450	558	538	422	554	443	440	360
0976776-MP	MN 86 MN 68	545	754	734	518	750	538	636	455
0976777-MP	MN 810 MN 108	945	729	709	918	725	938	611	855

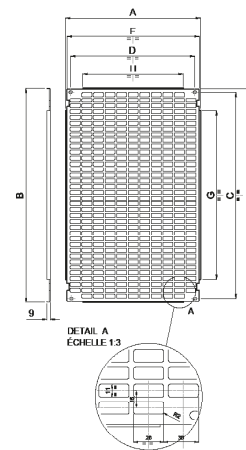

Accesorios

Sistemas de cierre

Todos los armarios estándar se suministran con cierre de doble barra DIN 3,0 mm.

Cierres

Amplia gama de cierres adaptables a todos los armarios



Doble barra DIN 3,0 mm (Estándar)
Ref. 0926456



Triangular 11 mm
Ref. 0926390



Manual+con llave
Ref. 0926391



Enclavamiento candado
Inox Ref. 0926665
Acero galvanizado
Consultar

Posibilidad de solicitar los armarios con otros tipos de cierre.

En estos casos añadir a la referencia del armario, el número de cierres y la correspondiente designación:

-CT: Cierres triangulares 11 mm, **-LLS:** Cierre superior con llave **-HCS:** Cierre superior con herraje candado

Ejemplo : 0470076-LLS = armario 800 mm alto x 600 mm ancho x 300 mm prof. con cierre superior con llave.

Maneta escamoteable

Amplia gama de sistemas de cierre con maneta escamoteable.



Cierre de doble barra (Estándar)
Ref. 0947253



Cierre con llave estándar
Ref. 0947258



Sin bombín
Ref. 0947259



Cierre triangular 11 mm
Ref. 0947254



Triangular 11 mm + dispositivo candado
Ref. 0947255

Posibilidad de solicitar los armarios con maneta escamoteable.

En estos casos añadir a la referencia del armario la correspondiente designación:

-LL: Cierre con llave estándar, **-SB:** Sin bombín, **-CT:** Cierre triangular 11 mm, **-HC:** Cierre triangular+dispositivo candado

Ejemplo : 0470076-LL= armario 800 mm alto x 600 mm ancho x 300 mm prof. con maneta y cierre con llave.

Fijación Mural

Set de fijación mediante 4 tirafondos con cabezal aislante.

Set de 4 soportes metálicos

Set de 4 soportes orientables.



Tirafondos desde interior (Todos los modelos)
Ref. 0926729

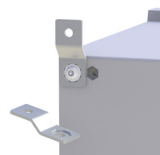

MN321 a MN652 Ref. 0926787
MN863 y MN683 Ref. 0926788



Fijación desde interior (Todos los modelos) Ref. 0926392
Fijación desde exterior (MN68, 86, 108 y 810) Ref. 0926392-86

Clip tuerca

Para la fijación de aparata en las placas base metálicas perforadas.



Clip tuerca M4 Ref. 0926730

Clip tuerca M5 Ref. 0926731

Clip tuerca M6 Ref. 0926732

Desplazamiento placa base

Set de 4 perfiles para el desplazamiento de la placa base a diferentes profundidades.



Kit para armarios :

MN432, 442 & 542 Ref. 0926393

MN642 & 652 Ref. 0926394

MN863 Ref. 0926395

Dispositivos de ventilación

Permiten la ventilación en el interior del armario.

(Instalar 2 dispositivos en cada armario para asegurar la correcta aireación del mismo.)



Estándar RAL 7035
Ref. 0976055
Grande RAL 7035
Ref. 0976056

Retenedor de puerta



Retenedor de puerta
Estándar Ref. 0947239
MN68 y MN108 Ref. 0947222

Obturadores

Conjunto de obturadores para cobertura parcial de las ventanas para automáticos.
Rápida fijación.
Fabricados en material aislante autoextinguible.

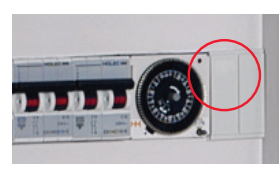

Set de 3 piezas de 1 módulo y 2 piezas de 1/2 módulo.
Ref. 0926728

Dispositivo de purga

Permite dar salida al agua en caso de condensación dentro del armario.
Fabricado en poliéster.

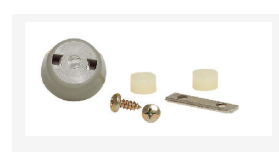

Para todos los armarios
Ref. 0926691

Dimensiones

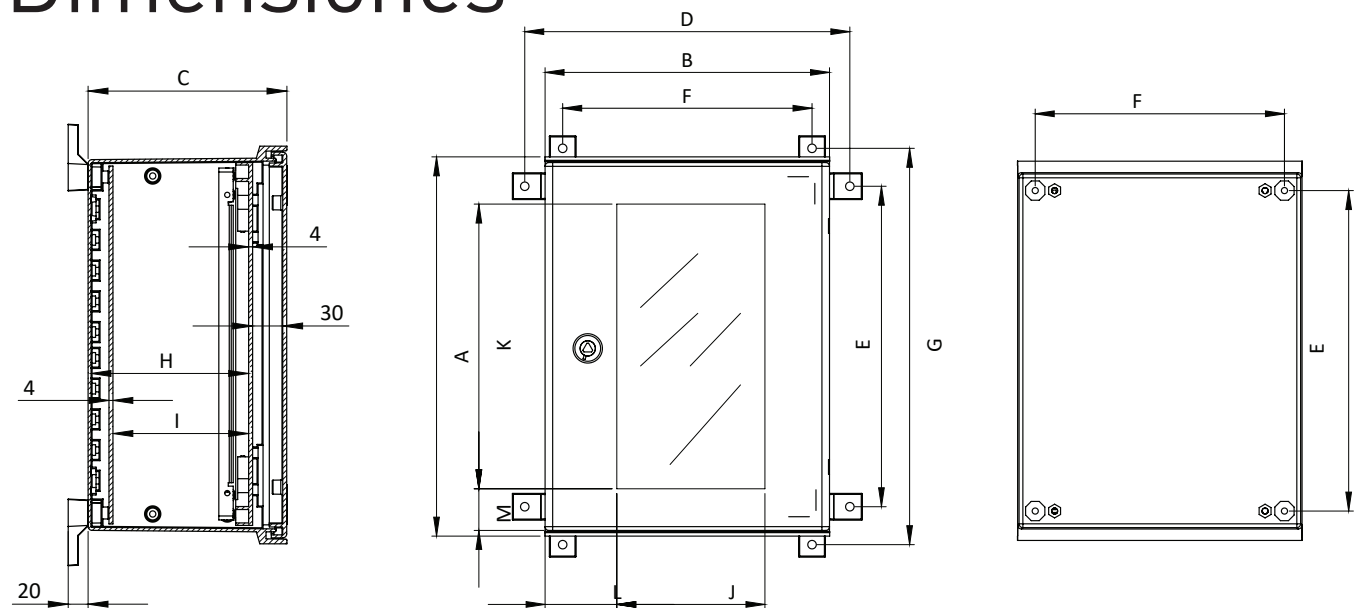

Dimensiones de los armarios (mm)

Referencia	Armario	A	B	C	D	E	F	G	H	I	J	K	L	M
0470071	MN 321	300	250	140	297	248	215	330	-	-	115	220	75	35,5
0470072	MN 432	400	300	200	344	338	262	420	158	138	121	281	89,5	53
0470024	MN 442	400	400	200	444	338	362	420	158	138	221	281	89,5	53
0470073	MN 542	500	400	200	444	438	362	520	158	138	221	381	89,5	53
0470095	MN 642	600	400	230	444	538	362	620	187	167	221	481	89,5	53
0470074	MN 652	600	500	230	544	538	462	620	187	167	321	481	89,5	53
0470098	MN 683	600	800	300	816	558	734	640	257	237	621	481	89,5	53
0470076	MN 863	800	600	300	640	734	558	816	257	237	421	681	89,5	53
0470841	MN 8103	800	1000	300	1038	709	958	789	257	237	621	481	189	153
0470840	MN 1083	1000	800	300	789	958	709	1038	257	237	481	621	153	189